



**The new
BAUER 2010
Standard**
The efficient
and open
geared motor
platform



 **Bauer**[®]
Gear Motor

An Altra Industrial Motion Company



Transmission Elements

Simple mechanical connection to your machine

Geared

Low complexity through

Machine

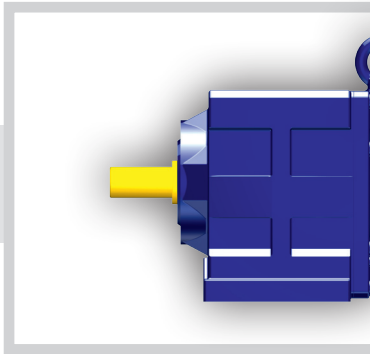
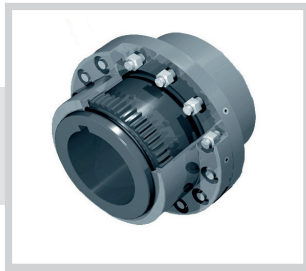

Modular Standard

- Conveying
- Material Handling

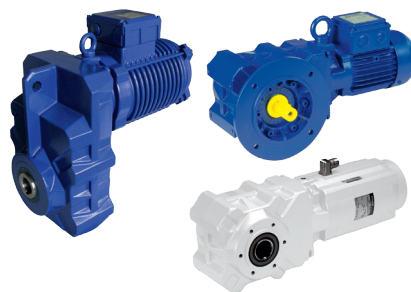

Application Specific Standard

- Food & Beverage
- Basic Metal
- Industries



Customer Specific Standard

- Customer specific drive solutions

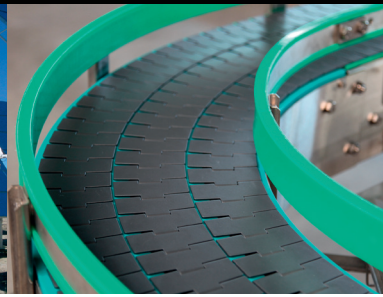

Motors

intelligent modular system

Control Electronics

Open systems for your application

Mains Supply

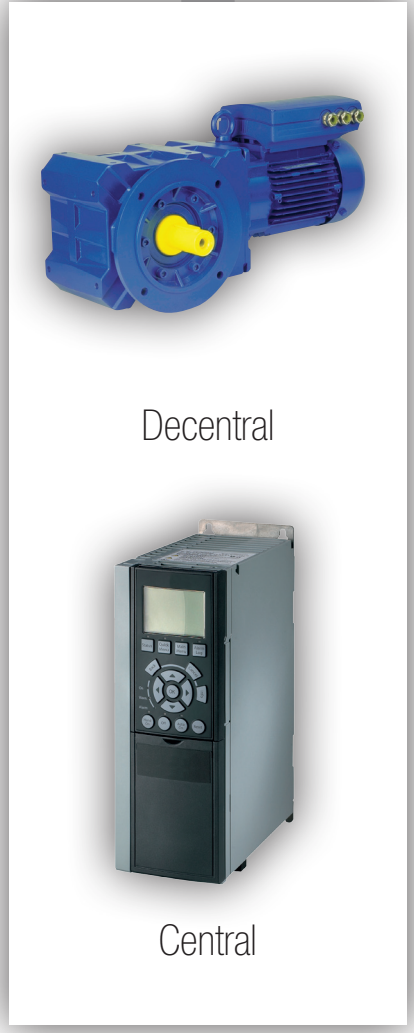
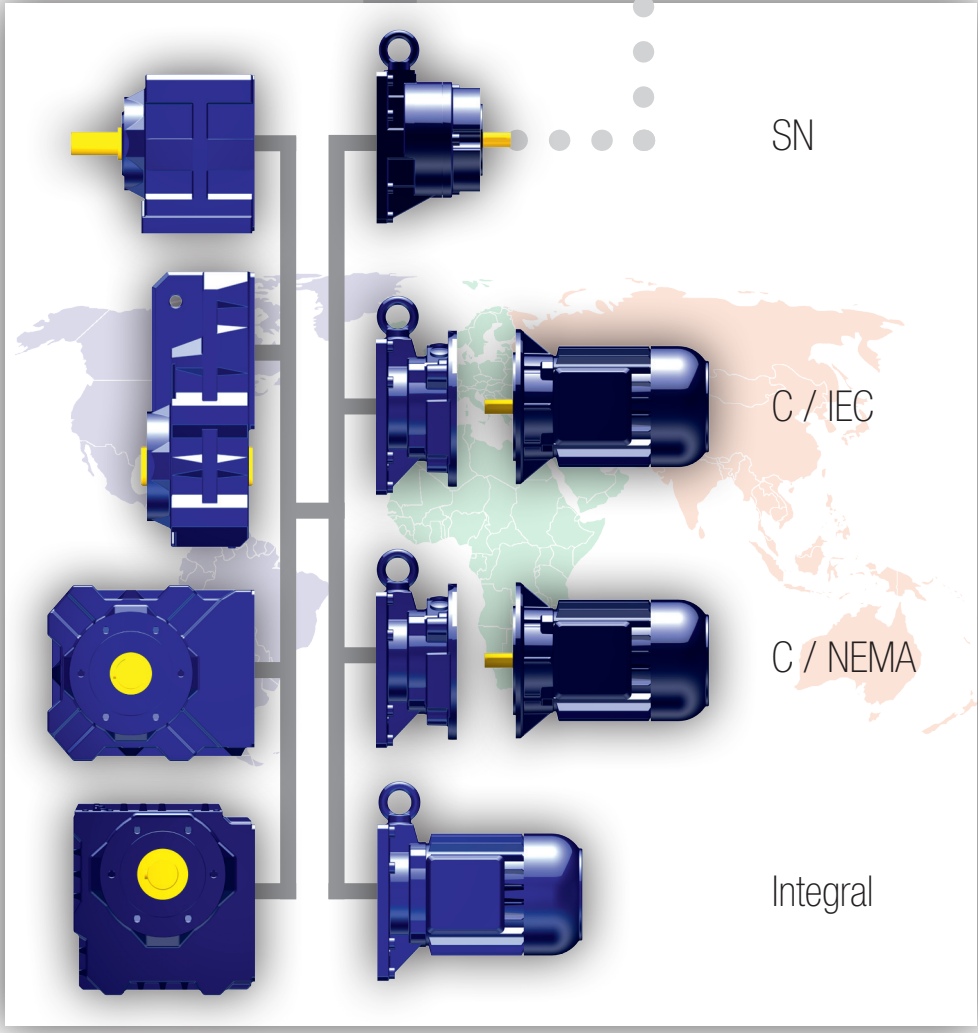
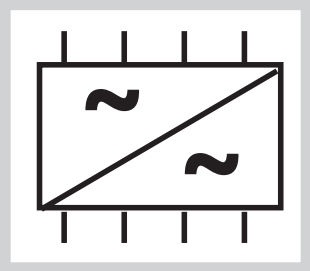
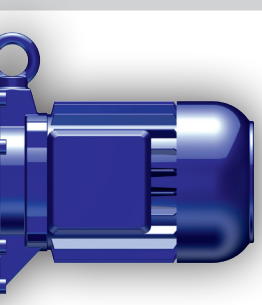



The new Modular Standard

The „All-Rounder“ for multiple applications

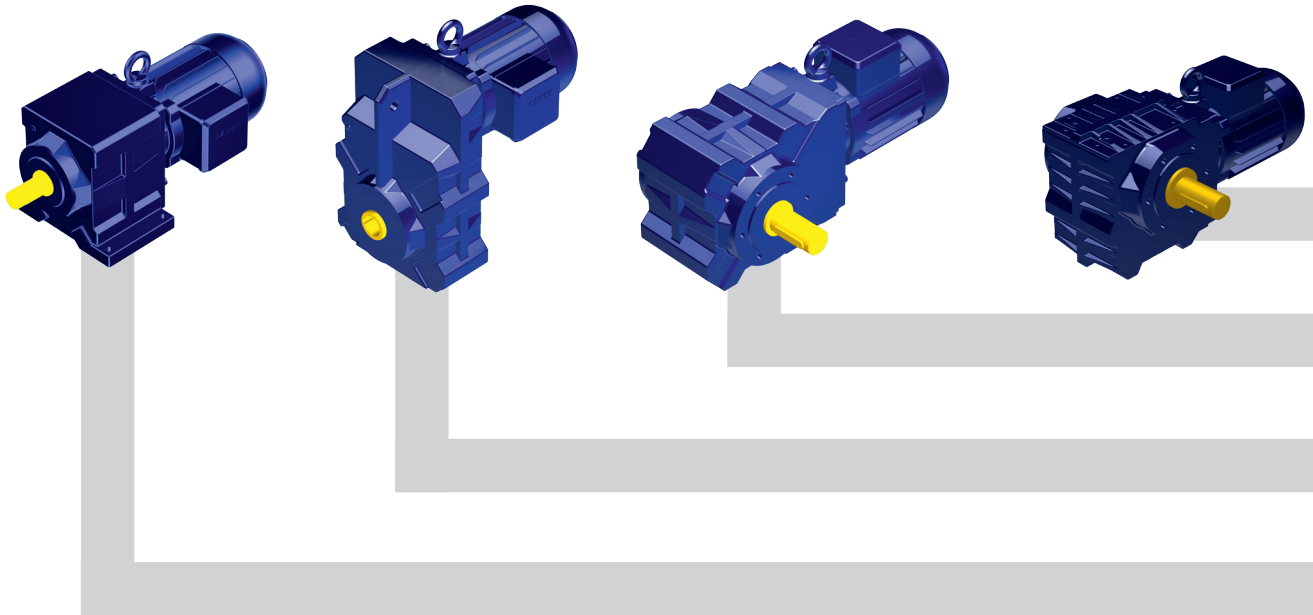

The Application Specific Standard

The „Application Master“ - the perfect fit for your application



Basic Metal

- Milltable
- Rolling mill

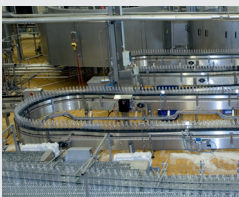

Food & Beverage

- Bottling plant
- Aseptic conveying
- Packaging



Industries

- Water and waste water technology
- Crane and conveyor technology
- Environmental technologies



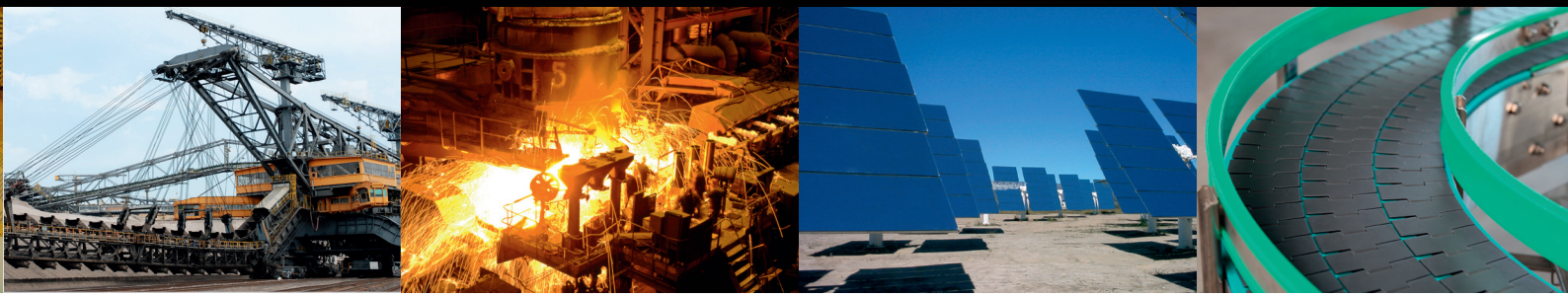

Gear Type	Power [kW]	Torque [Nm]	Your Benefit
Worm BS-Series	0,03 ... 5,5	25 ... 1.000	Compact and resilient through high quality worm gearing. Thus long lifetime and low servicing costs.
Bevel BK-Series	0,03 ... 75	80 ... 18.500	Energy efficient due to the highly efficient two-stage base design.
Parallel Shaft BF-Series	0,03 ... 75	90 ... 18.500	Compact mounting and multiple possibilities for attachment reduce the space requirements.
Helical BG-Series	0,03 ... 75	20 ... 18.500	Robust design leads to long service intervals.

The Customer Specific Standard

The „Integration Expert“ - optimally integrated in your machine.



Textile Industry

- Flat bed knitting machine
- Circular knitting machine
- Weaving machine

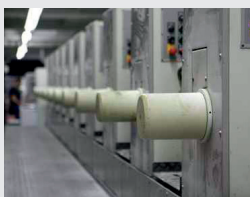

Printing Industry

- Offset printing machine
- Web and sheet offset



Packaging Industry

- Band strapping devices
- Pallet packing presses
- Rotary arm winder

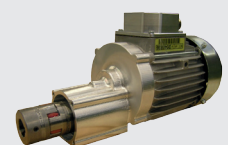
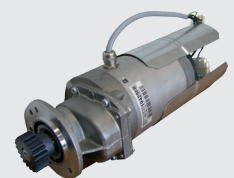



Integral Solutions

Three different rotor technologies which can be configured according to the efficiency class required, guarantee high efficient drive solutions without space restrictions.

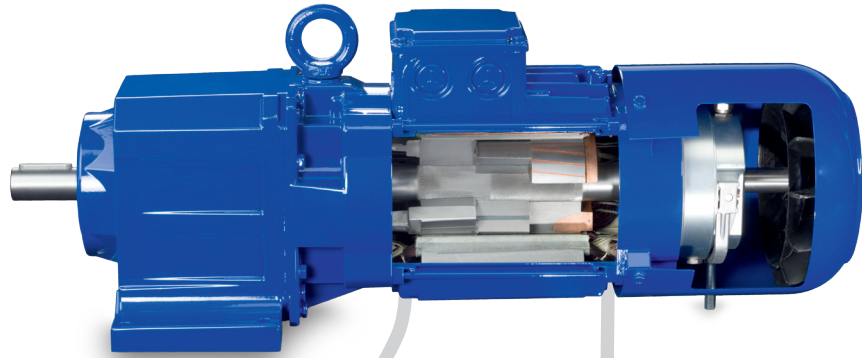

	ALU	COPPER	PSM
IE4			X
IE3	X	X	
IE2	X	X	
IE1*	X		

* for special applications

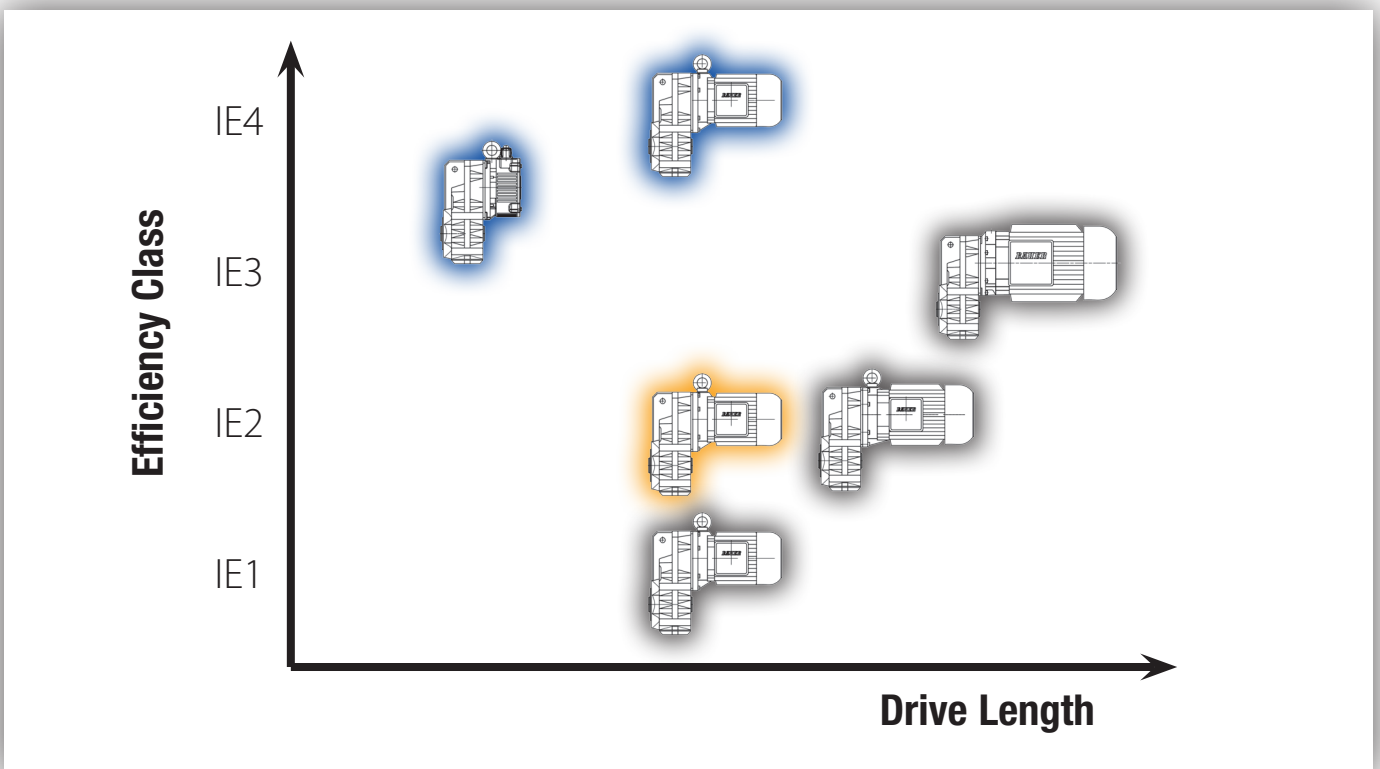

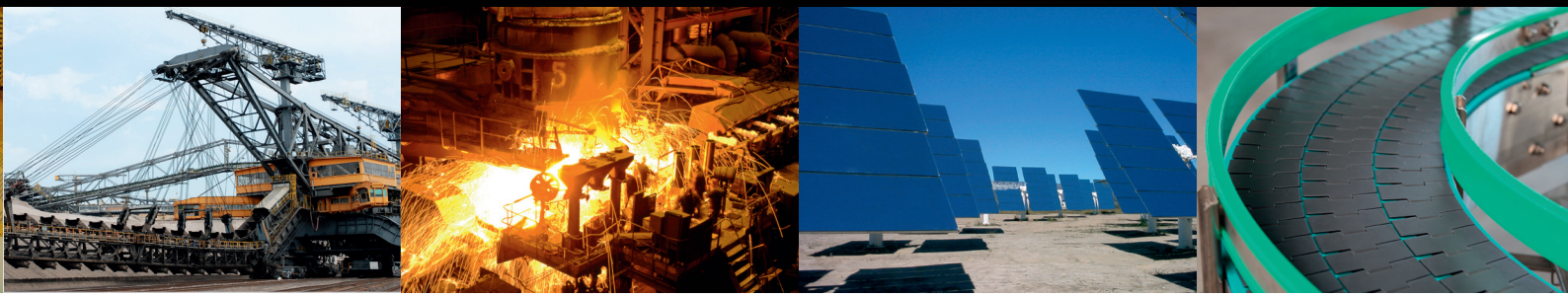

Modular Solutions

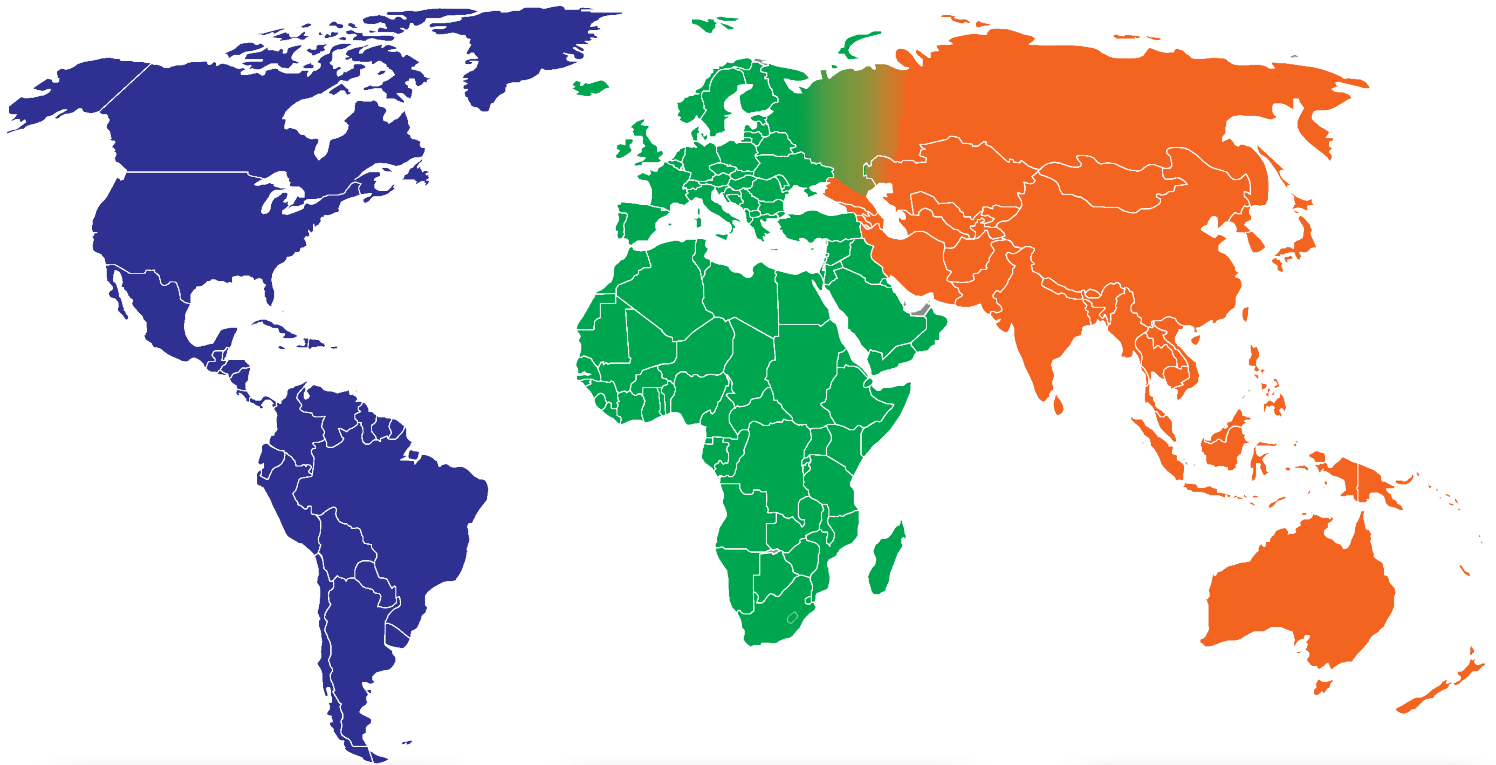

AMERICA

Integral

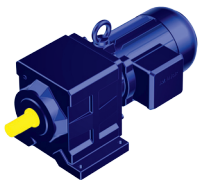

NEMA

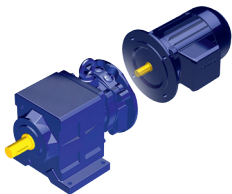

IEC

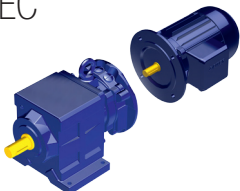

Europa, MEA

Integral

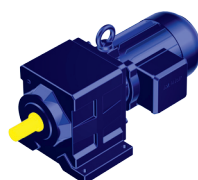

IEC

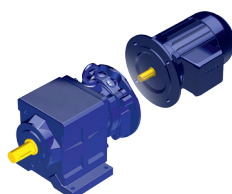

APAC

Integral

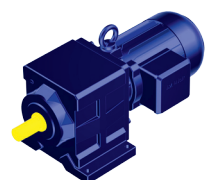

IEC

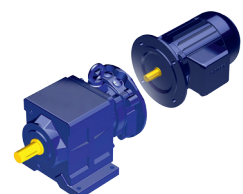

The modular concept allows the configuration of BAUER geared motors according to the legal requirements of all countries in the world.

Couplings

Ameridrives Couplings

Mill Spindles, Ameriflex, Ameridisc

Erie, PA - USA
1-814-480-5000

Gear Couplings

San Marcos, TX - USA
1-800-458-0887

Bibby Transmissions

Disc, Gear, Grid Couplings, Overload Clutches

Dewsbury, England
+44 (0) 1924 460801

Boksburg, South Africa
+27 11 918 4270

TB Wood's

Elastomeric Couplings

Chambersburg, PA - USA
1-888-829-6637 – Press #5

*For application assistance:
1-888-829-6637 – Press #7*

General Purpose

Disc Couplings

San Marcos, TX - USA
1-888-449-9439

Ameridrives Power Transmission

Universal Joints, Drive Shafts, Mill Gear Couplings

Green Bay, WI - USA
1-920-593-2444

Huco Dynatork

Precision Couplings and Air Motors

Hertford, England
+44 (0) 1992 501900

Charlotte, NC - USA
1-800-825-6544

Linear Products

Warner Linear

Linear Actuators

Belvidere, IL - USA
1-800-825-6544

*For application assistance:
1-800-825-9050*

St Barthelemy d'Anjou, France
+33 (0) 2 41 21 24 24

Electromagnetic Clutches and Brakes

Warner Electric

Electromagnetic Clutches and Brakes

New Hartford, CT - USA
1-800-825-6544

*For application assistance:
1-800-825-9050*

St Barthelemy d'Anjou, France
+33 (0) 2 41 21 24 24

Precision Electric Coils and Electromagnetic Clutches and Brakes

Columbia City, IN - USA
1-260-244-6183

Matrix International

Electromagnetic Clutches and Brakes, Pressure Operated Clutches and Brakes

Brechin, Scotland
+44 (0) 1356 602000

New Hartford, CT - USA
1-800-825-6544

Inertia Dynamics

Spring Set Brakes; Power On and Wrap Spring Clutch/Brakes

New Hartford, CT - USA
1-800-800-6445

Overrunning Clutches

Formsprag Clutch

Overrunning Clutches and Holdbacks

Warren, MI - USA
1-800-348-0881 – Press #1

*For application assistance:
1-800-348-0881 – Press #2*

Marland Clutch

Roller Ramp and Sprag Type Overrunning Clutches and Backstops

South Beloit, IL - USA
1-800-216-3515

Stieber Clutch

Overrunning Clutches and Holdbacks

Heidelberg, Germany
+49 (0) 6221 30 47 0

Heavy Duty Clutches and Brakes

Wichita Clutch

Pneumatic Clutches and Brakes

Wichita Falls, TX - USA
1-800-964-3262

Bedford, England
+44 (0) 1234 350311

Twiflex Limited

Caliper Brakes and Thrusters

Twickenham, England
+44 (0) 20 8894 1161

Industrial Clutch

Pneumatic and Oil Immersed Clutches and Brakes

Waukesha, WI - USA
1-262-547-3357

Gearing

Boston Gear

Enclosed and Open Gearing, Electrical and Mechanical P.T. Components

Charlotte, NC - USA
1-800-825-6544

*For application assistance:
1-800-816-5608*

Bauer Gear Motor

Gearred Motors

Esslingen, Germany
+49 (711) 3518-0

Nuttall Gear and Delroyd Worm Gear

Worm Gear and Helical Speed Reducers

Niagara Falls, NY - USA
1-716-298-4100

Belted Drives and Sheaves

TB Wood's

Belted Drives

Chambersburg, PA - USA
1-888-829-6637 – Press #5

*For application assistance:
1-888-829-6637 – Press #7*

Engineered Bearing Assemblies

Kilian Manufacturing

Engineered Bearing Assemblies

Syracuse, NY - USA
1-315-432-0700

Bauer Gear Motor

Bauer Gear Motor GmbH

Eberhard-Bauer-Strasse 36-60
73734 Esslingen - Germany

+49 711 3518 0
+49 711 3518 381 (Fax)

www.bauergears.com

Bauer Gear Motor s.r.o

Tovarenská 49
953 01 Zlate Moravce - Slovakia

+65 6487 4464
+65 6487 6674 (Fax)

www.bauergears.com

Bauer Gear Motor Limited

Nat Lane Business Park
Winsford, Cheshire
CW7 3BS - United Kingdom

+44 1606 868600
+44 1606 868603 (Fax)

www.bauergears.com

Bauer Gear Motor Finland Oy Ab

Yrittäjankuja 3
01800 Klaukkala - Finland

+358 207 189 700
+358 207 189 701 (Fax)

www.bauergears.com

Bauer Gear Motor LLC

31 Schoolhouse Rd.
Somerset NJ 08873-1212 - USA

+1 732 469 8770
+1 732 469 8773 (Fax)

www.bauergears.com

Bauer assumes no liability or responsibility for misprints and errors in catalogues, brochures and other printed documentation. Bauer reserves the right to make changes to products without prior notice, including to products that have already been ordered, unless contractual technical specifications are affected by such changes. All trademarks in these publications are the sole and exclusive property of the relevant companies. Bauer and the Bauer logo are trademarks of Bauer Gear Motor GmbH. All rights reserved.



www.bauergears.com

Eberhard-Bauer-Strasse 36-60
73734 Esslingen, Germany
Tel: +49 711 3518-0
Fax: +49 711 3518-381